

<BOL>Produced by USGS Product Generation Application</BOL>
 Display projection: Universal Transverse Mercator, Zone 15 North
 1000 Meter UTM Grid, Zone 15 North, NAD83
 No cartographic or geographic edits were performed on this data
 Selected data provided in the HSIP GOLD product is acquired from publicly available commodity vendors and is unclassified. Commercial data is restricted to Federal Users only. Exception to Releasability Restrictions stated above: In times of a Declared National Emergency the data in the HSIP data CAN be provided to the State & Local authorities at no additional cost for the duration of the crisis.
 Hydrography - USGS 24000 scale Digital Line Graph
 Hypsography - USGS 24000 scale Digital Line Graph
 Transportation - Department of Census
 Misc. Transportation - USGS 24000 scale Digital Line Graph
 Manmade Structures - USGS 24000 scale Digital Line Graph
 Labels - Geographic Names Information System

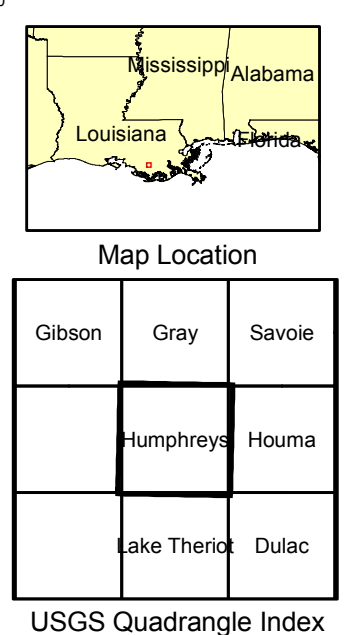
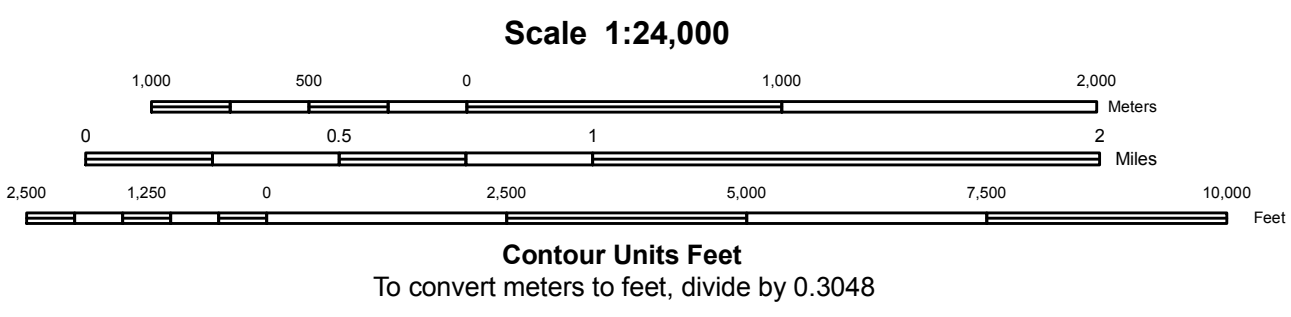

Road Legend

	Primary Route		Local Street
	Primary Route Separated		Driveway or Service Road
	Secondary Route		Ferry crossing
	Secondary Route Separated		